

# electricQ

## USER MANUAL

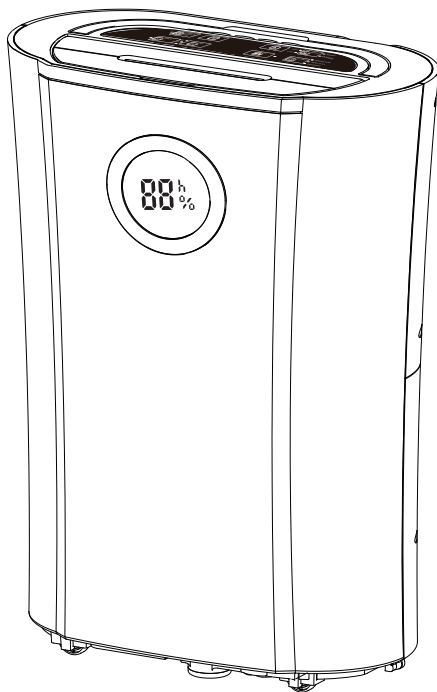

### **PREMIUM LOW ENERGY COMPRESSOR DEHUMIDIFIER WITH DIGITAL HUMIDISTAT AND AIR PURIFIER**

**CD12LEB – 12 Litres per day**

**CD20LEB – 20 Litres per day**

Thank you for choosing electricQ.

Please read this user manual before using this innovative dehumidifier and keep it safe for future reference  
Visit our page [www.electriQ.co.uk](http://www.electriQ.co.uk) for our entire range of Intelligent Electricals



## CONTENTS

SAFETY INSTRUCTIONS	2
INSTALLATION	5
PARTS	6
CONTROL PANEL	7
QUICK REFERENCE GUIDE	9
POSITIONING	11
WATER DRAINAGE	12
CARE AND MAINTENANCE	13
TROUBLESHOOTING	14
TECHNICAL DATA	15

# SAFETY INSTRUCTIONS

## IMPORTANT

- Carefully read the instructions before operating the unit
- This appliance is for indoor use only and intended for use in a domestic environment only. Any other use is not recommended by the manufacturer and may cause fire, electrical shocks or other injuries to user or property.
- Rating: This unit must be only connected to a 220-240 V / 50 Hz earthed outlet.
- Installation must be in accordance with the regulations of the country where the unit is used.
- If you are in any doubt about the suitability of your electrical supply, have it checked and if necessary, modified by a qualified electrician.
- This dehumidifier has been tested and is safe to use. However, as with any electrical appliance - use it with care.
- Disconnect the power before dismantling, assembling or cleaning.
- Avoid touching any moving parts of the appliance.
- Never insert fingers, pencils or any other objects though the guard
- This appliance is not intended for use by persons (including children) with reduced physical, sensory or mental capabilities. It is also not intended for use by those with a lack of experience and knowledge unless they have been given supervision or instruction concerning the use of the appliance by a person responsible for their safety.
- Do not leave children unsupervised with this appliance.
- Do not clean the unit by spraying it or immersing it in water.
- Never connect the unit to an electrical outlet using an extension cord. If a power outlet is not available, one should be installed by a qualified electrician.
- Never operate this appliance if the cord, power adapter or plug is damaged. Ensure the power cord is not stretched or exposed to sharp objects/edges.
- A damaged power supply cord should be replaced by the manufacturer or a qualified electrician in order to avoid a hazard.
- Any service other than regular cleaning or filter replacement should be performed by an authorized service representative. Failure to comply could result in a voided warranty.
- Do not use the appliance for any purpose other than its intended use.
- Do not tilt the unit while in use. The unit is designed to work only in a vertical position.
- This dehumidifier must always be stored and transported upright, otherwise irreparable damage may be caused to the compressor; if in doubt we suggest waiting at least 24 hours before starting the unit.
- Avoid restarting the dehumidifier unless 5 minutes have passed since being turned off. This prevents damage to the compressor.
- Never use the plug as a switch to start or turn off the dehumidifier. Use the provided ON/OFF switch located on the control panel.
- Always place the unit on a dry and stable surface.
- The appliance should not be installed in laundry or wet rooms where the humidity is higher than 85% RH
- Do not dry laundry above the unit to prevent water from entering the dehumidifier. Place the laundry at least 1 meter away from your dehumidifier.
- Before moving the appliance, the water tank should be emptied.



- The handle on the appliance is designed to aid in its movement and should not be used to support the full weight of the dehumidifier. When carrying the unit, it should be kept upright and sufficiently supported by its base.
- The handle should not be used if there are any signs of damage to its fixings.
- The appliance must be placed in a room without sources of ignition (for example open flames, an operating gas appliance or an operating electric heater).
- R290 refrigerant gas complies with European environmental directives.
- R290 has a low GWP (Global Warming Potential) of 3.
- The CD12LEB contains about 60g of R290 refrigerant gas.
- The CD20LEB contains about 75g of R290 refrigerant gas.
- Do not use or store the CD20LEB in an unventilated space with an area smaller than 4.1m<sup>2</sup> per unit.
- Do not use or store the CD12LEB in an unventilated space with an area smaller than 2.6m<sup>2</sup> per unit.
- If the appliance is installed, used or stored in an unventilated room, the room must be such as to prevent stagnation of possible leaks of refrigerant gas as there could be a danger of fire or explosion should the refrigerant come into contact with electric heaters, stoves or other sources of ignition.
- Refrigerant gas may be odourless.
- Do not use the product and contact the retailer for advice, if damage has occurred to the unit which may have compromised the refrigerant system.
- Any repairs or maintenance must only be carried out on the unit by a suitably qualified engineer. Before opening and servicing the unit the authorized engineer must be in possession of a copy of the manufacturer's service manual and must follow the safety information contained within it to ensure all hazards are minimized.
- The refrigerant system should not be perforated or punctured.
- Do not place the unit next to heat sources (e.g. electrical fires, fireplaces, etc.)
- Avoid mishandling the dehumidifier. Dropping, throwing the unit can cause damage to its internals and increases the risks of operating it.
- Do not store or use gasoline, petrol, paint, solvents or other flammable vapours or liquids in the vicinity of this dehumidifier or any other appliance.
- This dehumidifier must not be used in spaces where there is a high concentration of gases, solvent or other volatile organic compounds; in very dusty environments; in any domestic, commercial or industrial environment where the air composition is flammable.

## **ENERGY SAVING AND UNIT SAFETY PROTECTION TIPS**

- Do not cover or restrict the airflow from the outlet or inlet grills. Do not operate and follow troubleshoot procedure if the self-opening louvres do not open on power on.
- For maximum performance the minimum distance from a wall or objects should be 20 cm
- Keep the filters or grills of the unit clean. Under normal conditions, filters or grills should only need cleaning once every three weeks (approximately).
- Since the filters remove airborne particles, more frequent cleaning maybe necessary, depending on the air quality. Vacuum both mesh and optional carbon filters and wash the mesh filters with hot soapy water and dry them before placing them back in the unit.

# QUICK VISUAL SAFETY GUIDE ON WHERE OR WHEN NOT TO USE YOUR DEHUMIDIFIER



Exposed to the weather outdoors



Near water



If the power cable wires are frayed or cut



Where small children may be left unattended



If an extension lead may become overloaded



Where the power cable may be damaged



On a slope or uneven surface



Where there is risk of fire or close to a naked flame



Where it may be damaged by chemicals



Where there is a risk or interference by foreign objects



This product is not made for DIY repair



If there is a risk of water falling on the unit

# INSTALLATION

Remove any water from within the water tank before starting the unit. In order to save energy do not open windows or doors while the unit is running. Place the unit on a hard / flat surface. On first use run the unit continuously for 24 hrs.

## **TO REDUCE NOISE LEVELS:**

Place a piece of carpet or a rubber mat under the unit to reduce any vibrations while the unit is running.

The CD12LEB and CD20LEB dehumidifiers use compressor technology to extract water from the environment. Compressor dehumidifiers are ideal for normal domestic or office environments which are heated during the winter months and maintain a temperature above 12-15°C.

The dehumidifiers are easy to move around on castors and are designed to extract unwanted humidity while saving money due to their power-saving logic. They feature an intelligent humidistat where the desired relative humidity can be adjusted in increments of 5% between 40 and 80% ensuring your room is not dried too much and power is not wasted.

## **FEATURES**

Your dehumidifier belongs to the electriQ low energy premium dehumidifiers featuring low power consumption, power-saving logic and advanced air purification option.

1. Easy to use controls
2. Low energy only uses a fraction of the electricity of similar dehumidifiers
3. Great for up to 3 bed (CD12LEB) and 5 bed (CD20LE) houses
4. A cost-effective way to combat mould, condensation and damp
5. Dries laundry more efficiently than a tumble dryer
6. Designed to complement any modern space
7. Low and High fan speed selection for the best balance between running quiet and maximum water extraction
8. Anti-dust self-closing oscillating louvres for improved airflow
9. Castors for improved mobility
10. Intelligent CPU controlled digital humidistat with 35-80% RH and room humidity display
11. 24-hour start / stop timer
12. Tank operation or permanent drainage option with splash-proof tank
13. Tank full alarm & auto-stop function
14. Air purifier function with UV sterilisation

## PARTS

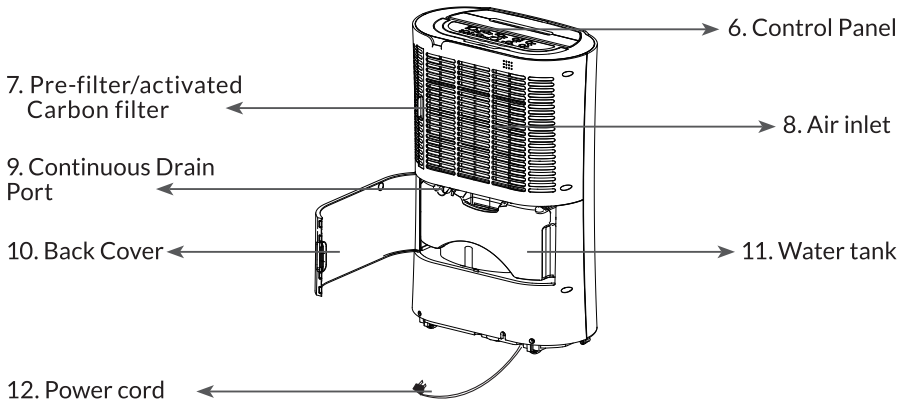
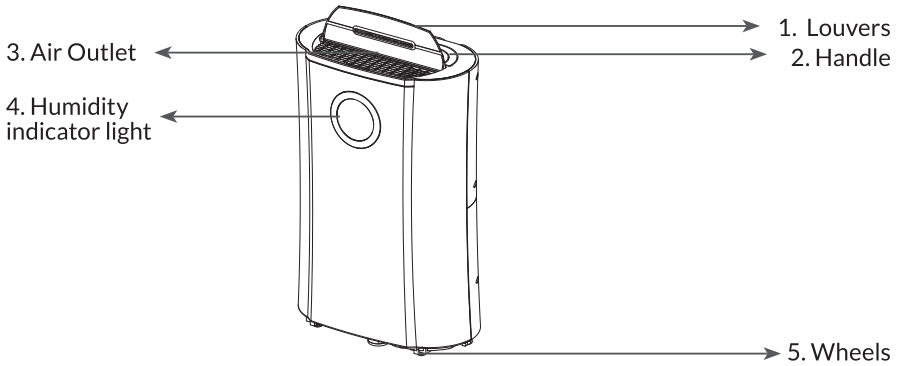



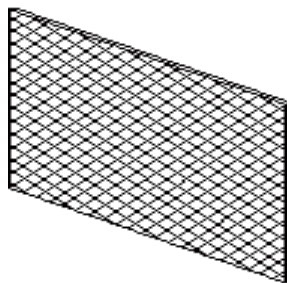

## OPTIONAL



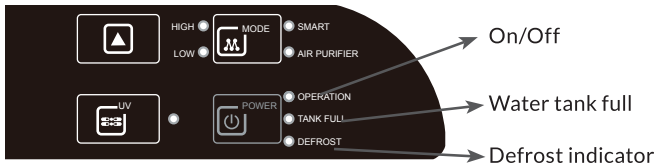
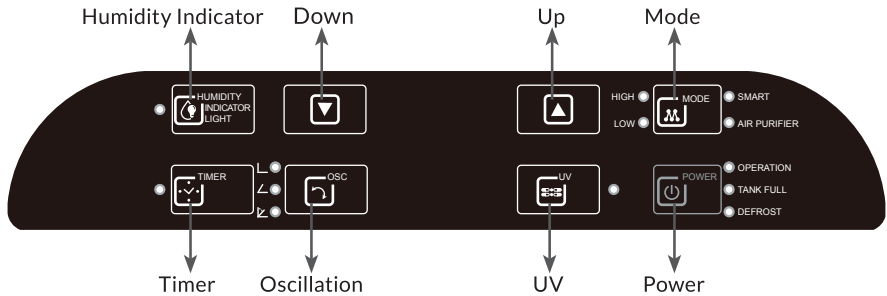



Activated carbon filter (Optional)

# CONTROL PANEL

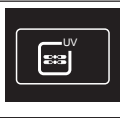

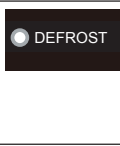
	<p><b>POWER</b> Turn the appliance on/off</p>
	<p><b>MODE Button</b> Select the function of the unit between SMART / HIGH / LOW / and PURIFIER. The LED's next to the button will show which mode is selected. <b>SMART MODE:</b> The unit will default to SMART mode the first time it is switched on and remains in this mode until another program is chosen. In smart mode, it will aim for a relative humidity of 50-55%, and the fan speed will be adjusted automatically. <b>HIGH:</b> The unit will dehumidify and aim for the humidity set using the up and down buttons. <b>LOW:</b> The unit will dehumidify and aim for the humidity set using the up and down buttons. <b>PURIFIER:</b> Only the fan will run and water is not extracted. Use with the UV function for improved air purification</p>
	<p><b>HUMIDITY INDICATOR MODE</b> When the appliance is first started the indicator light will turn on automatically. The colour of the indicator light will change according to the humidity condition of the room it is situated in. <b>RED:</b> High humidity, <math>RH \geq 70\%</math> <b>ORANGE:</b> Comfortable, <math>70\% &gt; RH \geq 60\%</math> <b>GREEN:</b> Dry, <math>RH &lt; 60\%</math> Press the "Humidity Indicator light" button to turn the light on/off. <b>NOTE:</b> It can take around 2 minutes following a change in the humidity for the indicator to change colour, e.g. If the humidity drops to 55% it may take 2 minutes before the indicator changes to green.</p>

	<p><b>OSC. (Oscillation function)</b></p> <p>There are three different options for the outer louvre on the unit. It can be set at 45 or 90 degrees, or alternatively to swing. Use the dehumidifier at a 45-degree angle or with the swing function for Laundry mode</p>
	<p><b>UV LIGHT (Air purifier function)</b></p> <p>To activate the UV function press the "UV" button and the indicator light will illuminate. The Germicidal UV light will destroy germs, bacteria, fungi improving the indoor air quality.</p>
	<p><b>HUMIDITY SETTING</b></p> <p>Press the UP and DOWN buttons to select the desired relative humidity level. The default relative humidity is 55%. When a relative humidity of 35% is selected, the compressor will not stop until the water tank is full.</p> <p><b>NOTE:</b> The desired humidity cannot be changed in SMART mode.</p>
	<p><b>TIMER</b></p> <p>Press the TIMER button to program the timer. When the timer is activated, the "TIMER" light will illuminate. Before programming the timer, ensure the timer function has not been activated (the light must be off). The following timer programs are available.</p> <p><b>DELAYED POWER-ON FUNCTION:</b> With the appliance in standby, press the TIMER button, then use the UP and DOWN buttons to set in how many hours time you require the unit to start (1~24 hours).</p> <p><b>DELAYED POWER-OFF FUNCTION:</b> While the appliance is running with the desired settings, press the TIMER button, then use the UP and DOWN buttons to set in how many hours time you require the unit to stop (1~24 hours).</p>
	<p><b>INTELLIGENT DEFROST</b></p> <p>The appliance will defrost automatically when the coil sensor detects that the internal temperature is too low. During defrosting the indicator will light up. Once the defrost cycle has finished, the appliance will return to the mode that was previously operating.</p>
	<p><b>TANK-FULL</b></p> <p>When the water tank is full, the TANK FULL indicator light will flash, and the unit will stop operating. One emptied and replaced, the appliance will resume operation.</p>
	<p><b>OPTIONAL CARBON FILTER (Air purification function)</b></p> <p>Remove the carbon filter from the bag and insert it on the filter housing. It is suggested to Hoover the carbon filter every 2-3 weeks and change it every 3-6 months as this will help to ensure the room is kept fresh and odour free.</p>

### HUMIDITY LEVEL & TIMER 2 DIGIT DISPLAY

The led indicator performs the following functions:



1. When the unit is plugged in, it will indicate the humidity level of the room.
2. When the UP and DOWN buttons are pressed, it will indicate the desired humidity currently set.
3. When the timer is programmed will show the duration.

**Notes:** When the humidity level is outside the normal operational parameters will show LO/HI. If the ambient humidity is lower than 20%, it will show "LO" If the ambient humidity is higher than 90%, it will show "HI"

## QUICK REFERENCE GUIDE





**Power Button:** Press to turn the dehumidifier on and off.



**Oscillation Button:** Press once to make the louvre swing and press again to lock at 45 degrees, press again to lock at 90 degrees. Do not operate the unit if the self-opening louvres do not open on power on.



**Timer:** Press the timer button, then use the   buttons to adjust the duration of the timer (1-24 hrs, start/ stop timer).

**If set while the unit is running:** The number will represent the number of hours the unit will operate before turning off. This will not be affected if the unit enters defrost mode or the tank is emptied and reinserted.

**If set while the unit is in standby:** the set number represents the period in hours after which the unit will start. To cancel the start / stop mode press the timer key again.



**Up and Down Buttons:** During the High or Low modes when the unit is displaying the current relative humidity, these buttons can be used to adjust the desired humidity level. The desired relative humidity can be set between 35 and 80% in 5% increments.

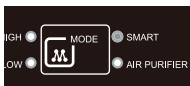

**SMART Mode:** This is designed for maximum convenience and maintains the ideal domestic environment humidity level of 50-55% while saving electricity. This is the default mode and is recommended for most users.

During use, the compressor will operate until the desired humidity is reached and then will stop. The economical low fan mode will continue to operate. The fan moves the air around the room ensuring the entire air in the room is processed and humidity correctly measured.

To achieve drier air, or while drying laundry, put the unit in High mode and use the down button to select a lower desired humidity (e.g. 35-45%).

**LAUNDRY MODE:** When drying clothes, it is advised for the dehumidifier to operate continuously with maximum water extraction until the water tank is full. Set the unit to the High mode, and set the desired humidity level between 35%-50%. 35% is very dry and is hardly achievable in a UK domestic environment. As such the unit will work until water tank is full when set to 35%. Set the louvres to swing mode or to 45 degrees directing the airflow onto the clothes. Do not place clothes directly over any of the vents on the dehumidifier. Make sure that there is nothing blocking the hot air exhaust airflow and for best results place the laundry within 1.5 meters of the dehumidifier.

### NOTES:

- If a permanent drainage pipe is fitted the unit will not stop operating. Setting the desired humidity to around 35% is good for laundry mode, a quick-drying boost, or in emergencies. It is not recommended for long operation in a domestic or office environment.
- To allow more moisture in the air, press the up button and set to a higher desired humidity (e.g. 60-70%).
- We recommend setting the Humidity to 50-55%. This is great for domestic operation and dry storage
- Setting the humidity to 60% is great for personal comfort and applications where 50% RH is considered too dry
- Setting the humidity to 70% is ideal for unoccupied properties or where an economical run is needed without the need to reduce the humidity further.

## **OTHER FEATURES AND INDICATORS**

### **TANK FULL LIGHT**

When the water tank is full, removed or incorrectly inserted the unit will stop dehumidifying, the red tank full light will illuminate and the unit will beep. Empty the tank and reinsert it correctly to resume operation.

### **AUTO DEFROST**

When frost builds up on the evaporator coils, the compressor will cycle off and the unit will go in to defrost mode. Following the completion of the defrost mode, the unit will return to the previously operating settings.

- When the unit is running in a room with a temperature between 5°C and 12°C, it will enter defrost mode roughly every 30 minutes.
- When the unit is running in a room with a temperature between 12°C and 20°C, it will enter the defrost mode roughly every 45 minutes.

### **HUMIDISTAT CONTROL AND FAN/COMPRESSOR OPERATION**

- When the humidity of the room is 2% lower than the desired humidity the compressor will turn off automatically but the fan will continue to operate to ensure that the air within the room is not stale. The unit will use only a minimal amount of energy in fan mode.
- When the humidity of the room is equal to or higher than the desired humidity the compressor will restart after a 3 minutes delay to protect the compressor.

### **AUTO-RESTART (on some models)**

If the unit stops unexpectedly due to the power cut, it will restart with the previous function selected automatically when the power resumes, and the 3-minute compressor protection has elapsed.

### **POWER**

After the unit has stopped, to protect the compressor it is not recommended to resume operation for at least 10 minutes. Operation can resume after this period lapses. When the unit is restarted there is a 3 minutes delay before the compressor will start.

### **LIGHTWEIGHT PORTABLE DESIGN ON CASTORS**

The dehumidifier is built to be compact and lightweight. The castors on the bottom of the unit make it easy to move from room to room.

Your dehumidifier contains an advanced micro-CPU controlled device which is capable of self-diagnostics. The LCD display may also show the error and protection codes.



## POSITIONING THE DEHUMIDIFIER

A badly positioned dehumidifier will have little effect. In positioning the dehumidifier please ensure circulation of air is not restricted around the unit.

Allow at least 20 cm space around the unit. This dehumidifier is designed only for indoor residential or small office applications and any commercial or industrial use will invalidate the warranty.

Use in an enclosed area for maximum efficiency. Close all doors, windows to create an effective operating environment. Do not use outdoors.

Your electriQ dehumidifier will begin to protect your space from the harmful effects of excessive moisture as soon as it is turned on. Excess moisture is dispersed throughout your home. For this reason, the dehumidifier should be positioned in a central and clear location so that it can draw this moist air towards it from all over the home. A warm hallway or landing is an excellent position for your dehumidifier. If possible, leave interior doors ajar to allow air circulation.

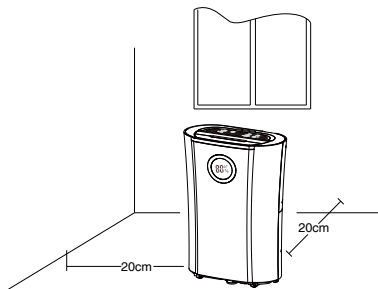

Alternatively, if you have a serious problem in one area you can begin by positioning the dehumidifier there and moving it to a more central location at a later date. For the most effective use, run your dehumidifier with external doors and windows kept closed. Please note the unit should not be placed directly against a radiator or other heat source.

Before moving the appliance the water tank should be emptied. The handle on the appliance is designed to aid in its movement and should not be used to support the full weight of the dehumidifier. When carrying the unit, it should be kept upright and sufficiently supported from its base. The handle should not be used if there is any signs of damage to its fixings.

When positioning your electriQ dehumidifier, ensure that it is placed clear of any obstacle that may limit the air movement. Place the dehumidifier on a flat dry surface.

**Note:** Do not force castors to move over carpet or uneven surfaces, nor move the unit with water in the tank as it may tip over and spill water.

# WATER DRAINAGE

When the water tank is full, the unit will stop automatically. When this happens the **TANK FULL** red light will show on the control panel, and the unit will bleep.

**NOTE:** Only empty the water tank when it is full or before moving or storing the unit. There are two ways to dispense collected water.

## 1. USE THE TANK

When the tank is full, the unit will automatically stop running, and the Tank Full indicator will flash.

Slowly pull out the tank. Grip the tank by its handle securely, and carefully pull it out. Empty the water tank and reinsert it into the dehumidifier. The tank must be in place and securely seated for the dehumidifier to operate again. The dehumidifier will re-start when the tank is restored in its correct position.

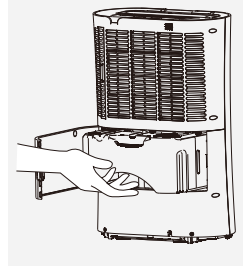

## NOTES:

When you remove the water tank, do not touch sensors or any parts which are situated behind the tank. Doing so may damage the product. Be sure to push the tank gently all the way into the unit. Banging the bucket against anything or failing to push it in securely into place may cause the unit not to operate.

Do not remove any parts from the water tank or tank enclosure. The water full sensor will no longer be able to detect the water level correctly and water may leak from the water tank.

## 2. CONTINUOUS DRAINAGE

Water can be automatically plumbed in or drained into a sink, a larger recipient or through the wall into an outside drain by attaching a pipe to the unit (10 mm internal diameter) (not included). Insert the pipe into the drain outlet at the back of the unit as shown here.

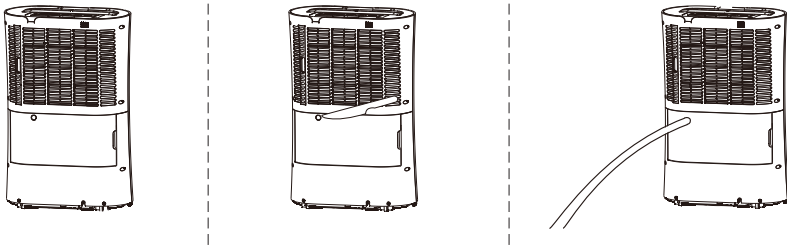

Make sure the connection between the pipe and the drain outlet is tight and does not leak. Then direct the pipe to a suitable drainage point. This unit uses gravity to dispose of water hence the drain should be lower than the water outlet on the unit. Put the tank back. Be sure to run the water pipe downward and let the water to flow out smoothly. Do not kink or bend the pipe.

The permanent drain can be used in conjunction with a water pump (e.g. when draining from a cellar) to lift the water upwards.

## CARE AND MAINTENANCE

Always shut off the unit and unplug from the mains before cleaning or performing any maintenance. When it is not in use for long periods it is advisable to remove the plug from the power socket. Do not use chemical solvents (such as benzene, alcohol or gasoline) as they may cause irreversible damage to the unit.

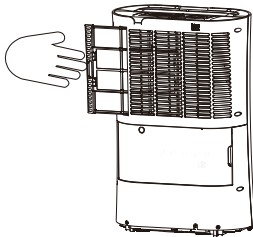

### 1. CLEAN THE GRILLE AND CASE

Use water and a mild detergent to clean the washable mesh filters. Do not use bleach or abrasives. Do not splash water directly onto the main unit. Doing so may cause an electrical shock and can lead to the insulation to deteriorate, or cause the unit to rust. The air intake and outlet grilles get soiled easily, so use a vacuum attachment or soft brush to clean. Wipe the dehumidifier body with a soft damp cloth or kitchen towel.

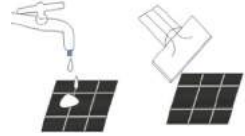

Remove the ABS filter frame. If the optional carbon filters are fitted, remove them from the frame and Hoover gently approximately every 2-3 weeks.

If the mesh filter is dirty Hoover it, if it is heavily soiled wash it with warm soapy water and dry thoroughly before reinserting it in the unit.

When filter cleaning is finished and filters are dry placed them back into the unit.

**NOTE:** While the carbon filter is optional never run the unit without the mesh filter frame correctly inserted.

### 2. CLEAN THE WATER TANK

Every few weeks, clean the tank to prevent the growth of mould, mildew and bacteria. Partially fill the tank with clean water and add a little mild detergent. Swish it around and then empty the tank and rinse.

**NOTE:** Do not use a dishwasher to clean the tank. After cleaning and drying, the tank must be reinserted securely into dehumidifier in order to restart operation.

### END OF SEASON MAINTENANCE

1. Empty and clean the water tank.
2. Clean the unit and the filters as per the cleaning procedure above.
3. Coil the power cord on the special cord storage rest at the back of the unit
4. Cover the unit and keep it in a dry place.

### FREQUENTLY ASKED QUESTIONS

Why doesn't the dehumidifier seem to extract much water if the temperature is low?

This is a compressor dehumidifier which works best in temperatures above 15°C. If the temperature is low and the air is dryer than the setting on the humidistat the unit will not extract water. If you want to use a dehumidifier for outside buildings, unheated properties, boats or garages please check our desiccant range.

Why doesn't the unit work /or stops suddenly?

The water tank may be full or displaced. To rectify: empty the tank and carefully place the tank back in the unit. Also, the unit may be running in dehumidifying mode with a low room temperature. Please check if the room temperature is lower than 5°C. If so, the unit will stop working while in dehumidifying mode. (unit may be defrosting).

The ambient operating range is between 5°C and 35°C with a relative humidity ranging from 30% to 80%. For maximum efficiency use the unit between 15°C and 32°C.

Sometimes cold and/or hot air comes out from the air outlet grill, why?

When the unit is in dehumidifying mode it absorbs humid air from the room and freezes it to reduce the humidity.

During the cold cycle there should be cold air coming out of the unit

During the hot cycle hot dry air should be coming out of the outlet grill.

## TROUBLESHOOTING :

Issue	Cause	Solution
Hot or cold air being produced	Normal Operation	When the unit is in dehumidifying mode it absorbs humid air from the room and freezes it to reduce the humidity. During the cold cycle there should be cold air coming out of the unit. During the defrost cycle hot dry air should be coming out of the outlet grill.
The unit does not operate	Is the plug properly inserted in the socket?	Insert the plug into the socket and turn the switch on.
	Does the tank full indicator is red?	Tank full, float displaced or tank not properly inserted. Empty tank, check float and make sure the tank is properly inserted in unit.
Front louvres do not open	Louvre motor is blocked	Check if anything is blocking the louvre Try to move the louvres gently up and down while the unit is off If the above fails return the unit to service centre
Dehumidifier does not extract water	Is the unit set to a humidity level lower than the one in the room?	Set the humidity level on the humidistat below current humidity reading.
	Is the temperature too low for water extraction to be efficient?	Increase the temperature in the room or reposition the unit.
	Is any intake grill or discharge blocked? Is the unit too close to walls?	Remove obstructions and restart the unit. Ensure a distance of at least 20 [cm between the unit & walls
Airflow seems weak	Is filter dirty or clogged?	Please service the filters regularly as per user manual.
Unit is noisy during operation	Is the unit on an uneven surface?	Please place on a flat horizontal surface.
	Is filter clogged?	Please service the filters regularly as per user manual.
E3 or E4	Humidity sensor error	Use the unit within the prescribed humidity range. Unplug the unit, rest and plug it back in. If error repeats, contact the service centre.
E1 or E2	Temperature sensor error	Use the unit within the prescribed temperature range. Unplug the unit, rest and plug it back in. If error repeats, contact the service centre.
E5 or E6	Abnormal Coil sensor temperature or current	Use the unit within the prescribed humidity and temperature range. Unplug the unit, rest and plug it back in. If error repeats, contact the service centre.
Defrost light on and the unit stops regularly	Unit is defrosting	Allow the unit to automatically defrost. The protection will clear after the unit self defrosts. Increase the temperature in the room if this repeats too often
Tank full red light	Water tank full notification	The tank is full or is not in the right position-- Empty the tank and replace in the right position.
Any other malfunctions will need to be reported to electriQ service centre. Do not attempt unauthorised repairs as these may invalidate the warranty.		

## TECHNICAL DATA

Model	CD12LEB	CD20LEB
Voltage	1Ph, 220-240V~ 50Hz	1Ph, 220-240V~ 50Hz
Dehumidifying capacity	12 L / day (at 30°C / 80%RH)	20 L / day (at 30° C / 80%RH)
Fan Speeds	2	2
Power Consumption	180W	270W
Running Amps	0.91 Amps	1.2 Amps
Tank Capacity	4 litres	4 litres
Humidity settings range	35%~80%	35%~80%
IP RATING	IPX1	IPX1
Refrigerant	R290, 60 grams	R290, 75 grams
Airflow m <sup>3</sup> /h	180	180
High / Low Pressure	3.2/0.7MPa	3.2/0.7MPa
Max noise level dB(A)	42-49	42-49
Filters	carbon (optional)	carbon (optional)
Dimensions mm (WxHxD)	380x580x195	380x580x195
Weight kgs	14.3	14.3
GWP	3	3
All information provided is for reference only. Products specifications may change due to continuous product development.		

**Disposal: Do not dispose of this product as unsorted waste. Collection of such waste must be handled separately as special treatment is necessary.**

Recycling facilities are now available for all customers at which you can deposit your old electrical products. Customers will be able to take any old electrical equipment to participating sites run by their local councils. Please remember that this equipment will be further handled during the recycling process, so please be considerate when depositing your equipment. Please contact the local council for details of your local household waste recycling centres.



**Please, for your own convenience, make these simple checks before calling the service line.**

1. Has the unit been standing upright for at least 2 hours?
2. Is the unit plugged into the mains?
3. Is the fuse OK?
4. Switch the unit off and wait three minutes to see if the issue is resolved. Restart the unit.
5. Check if the water tank is full.
6. Was the troubleshooting guide followed?

If the unit still fails to operate call: 0871 620 1057 or complete the online form

Office hours: 9AM - 5PM Monday to Friday

Unit J6, Lowfields Business Park,  
Lowfields Way, Elland  
West Yorkshire, HX5 9DA



